

Service Information

Mazda Motor Corporation

3-1, Shinchi, Fuchu-cho, Aki-gun
Hiroshima 730-8670, Japan
TEL : 81(82)287-5323
FAX : 81(82)287-5220



Category S	Technical	Ref. No. E001/17	Page 1 of 12
Coverage <input type="checkbox"/> Distributor only <input checked="" type="checkbox"/> Please inform your dealers		Date Issued January 11, 2017	
Please convey this information to your <input type="checkbox"/> Director <input checked="" type="checkbox"/> General Manager <input checked="" type="checkbox"/> Warranty Dept. <input checked="" type="checkbox"/> Parts Dept. <input checked="" type="checkbox"/> Training Dept. <input checked="" type="checkbox"/> Field Rep.		Date Revised	
Applicable Model MX-5 (ND)	Applicable Countries and/or Vehicle Specifications Europe		

Subject: Service Caution when installing Windshield Garnish

DESCRIPTION

When installing the windshield garnish during the windshield repair or any other service opportunity, make sure to follow the procedure "WINDSHIELD GARNISH REMOVAL/INSTALLATION" in this Service Information.

CAUTION: If the windshield garnish is not installed securely, there is a possibility of the windshield garnish coming loose by wind pressure during high speeds driving.

Kimiaki Inooka
Manager, Technical Information Group
Technical Service Department
Mazda Motor Corporation
2G42510558 (MC Internal Use)

MX-5 (ND) / WINDSHIELD GARNISH REMOVAL/INSTALLATION

1. Open the convertible top.
2. Disconnect the negative battery cable.
3. Remove the A-pillar trim.
 - 1) Move the A-pillar trim in the order of arrows (1) and (2) shown in figure, and detach clips A and B from the dashboard



- 2) Pull the A-pillar trim in the direction of the arrow shown in figure and remove it while releasing the guides.

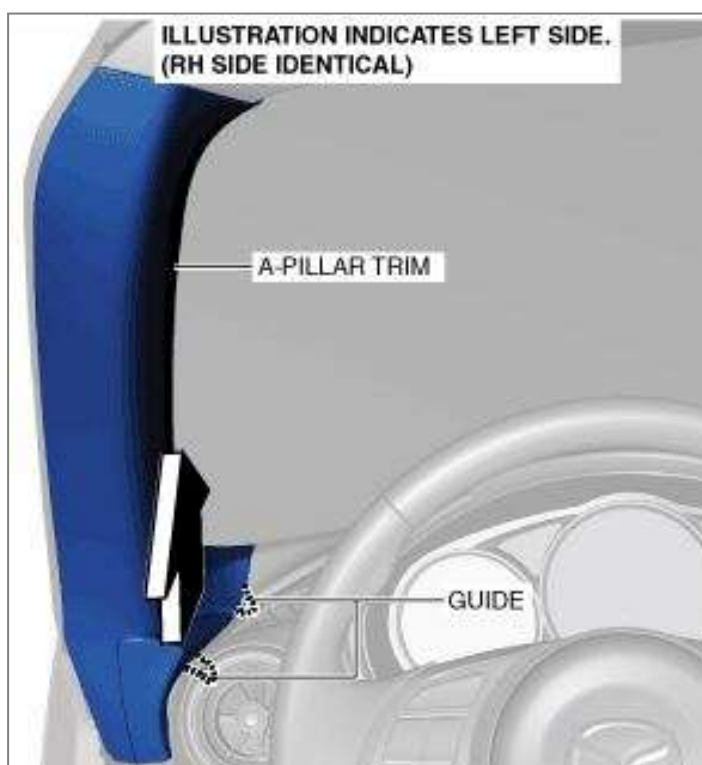

- 3) Release the tabs in the positions shown in figure and remove the tweeter from the A-pillar trim.

NOTE: The tweeter connector cannot be disconnected with the tweeter installed to the A-pillar trim.

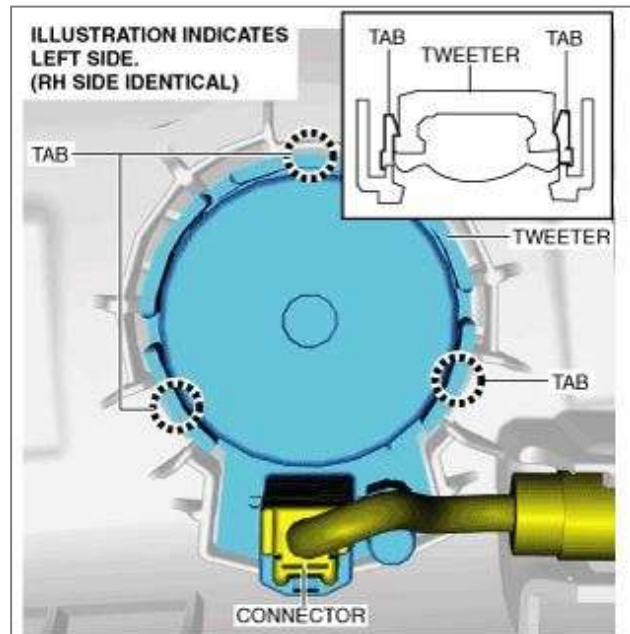

- 4) Disconnect the connector.
5) To remove the lower A-pillar trim, release the tabs in the positions shown in figure and remove it from the A-pillar trim.

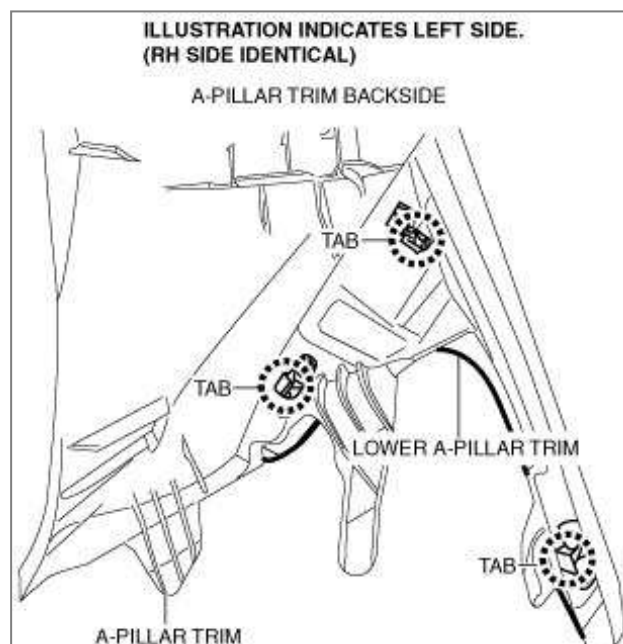

4. Remove the female wedge.
 - 1) Place alignment marks on the female wedge and the female wedge installation screws (LH).
 - 2) Remove the screws.

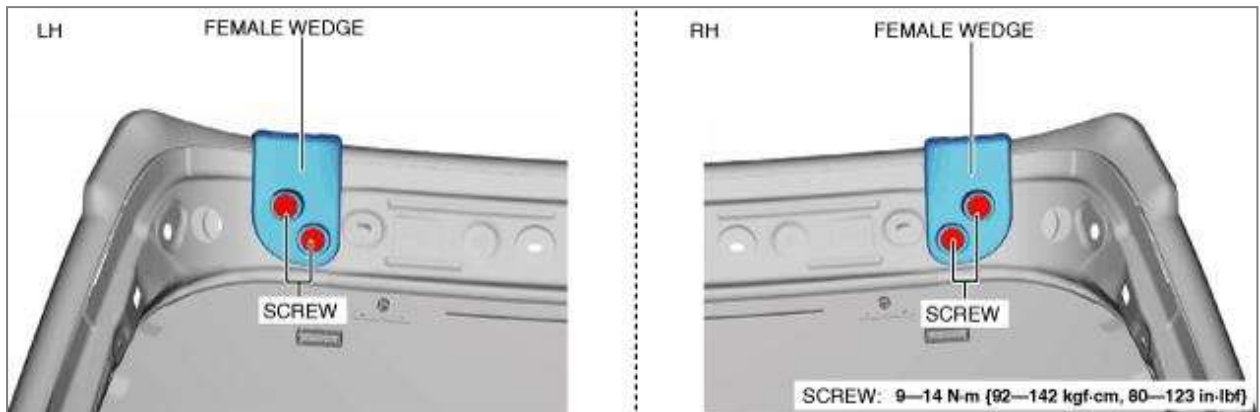

- 3) Remove the female wedge.

5. Remove the front header trim.

- 1) Remove the screws.

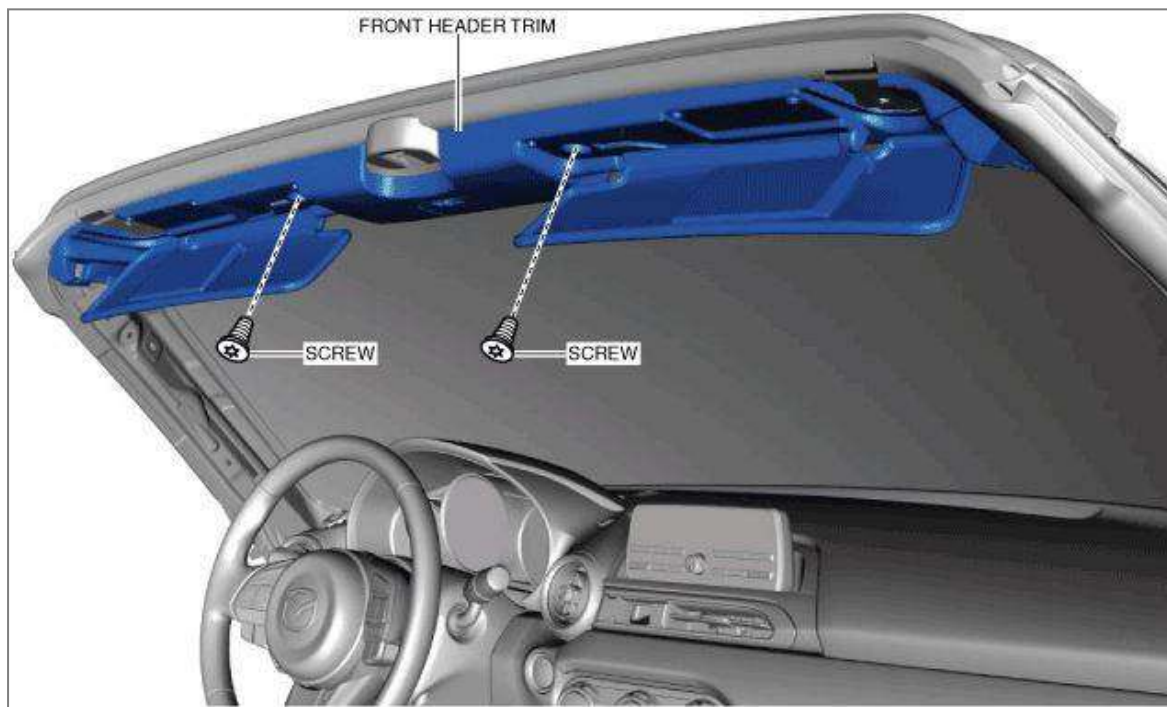

- 2) Move the front header trim in the order of arrows (1), (2) and (3) shown in figure and remove it while detaching the clips.

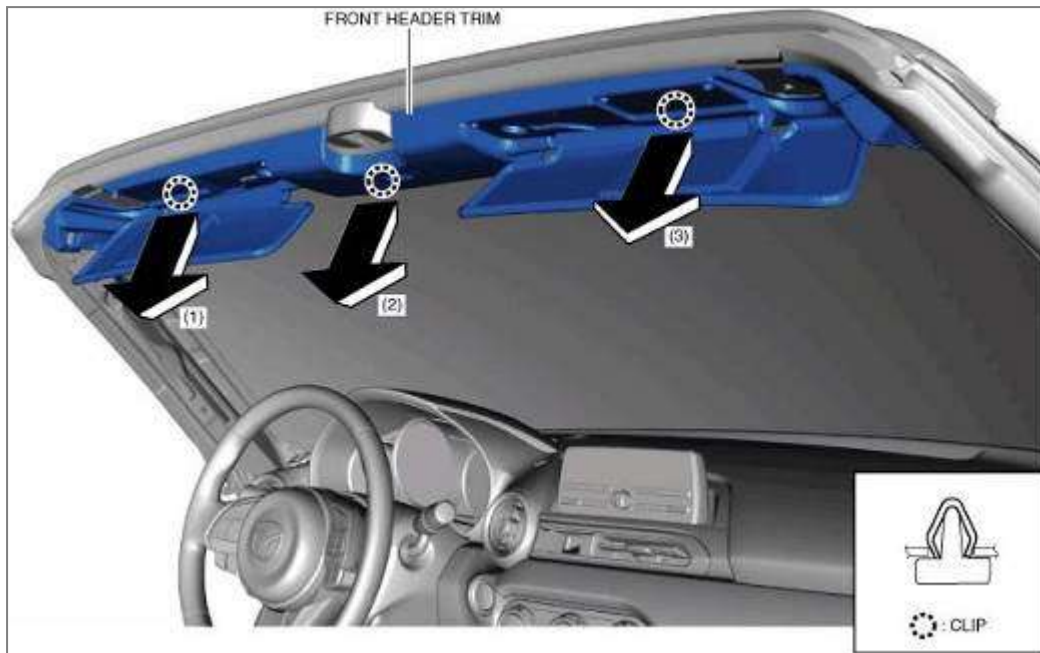

- 3) Disconnect the map light connector.

6. Remove the nuts.

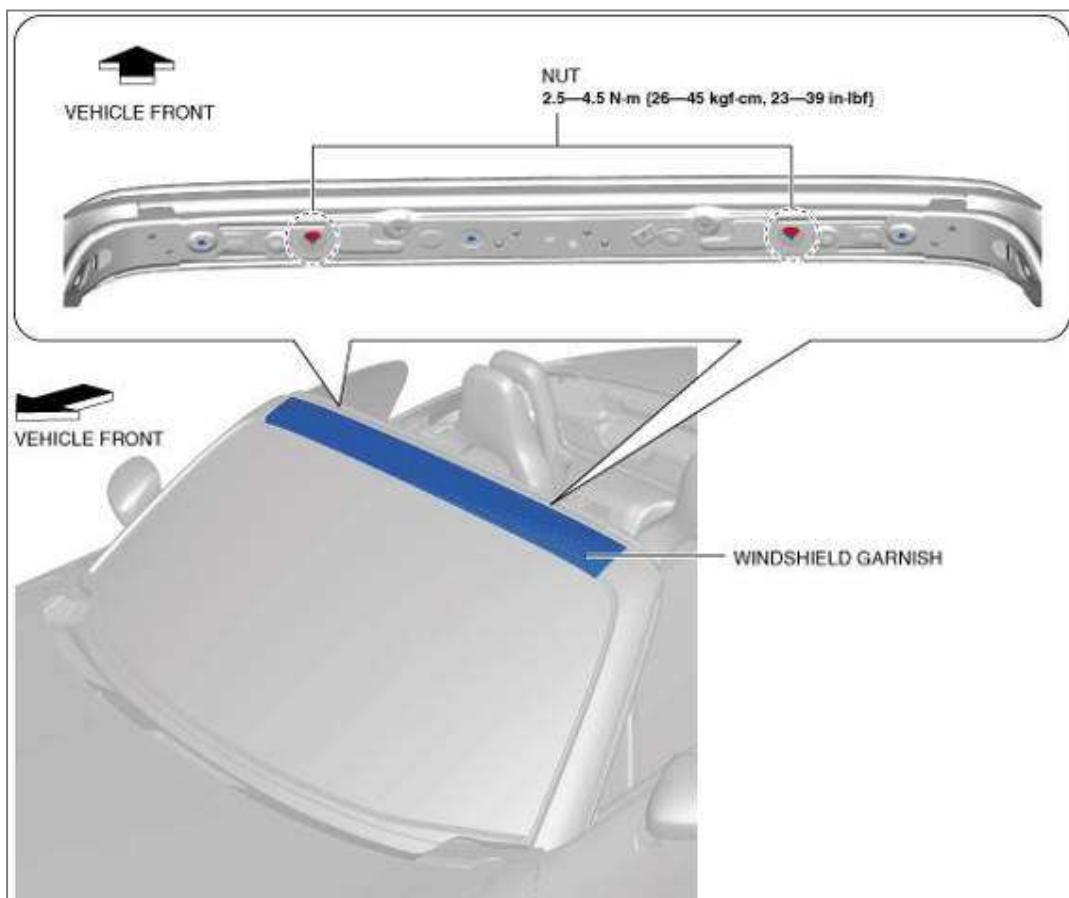

7. Insert a tape-wrapped flathead screwdriver into the positions shown in figures, rotate it in the direction of the arrows and detach the windshield garnish clips A and clips B. Then, Remove the windshield garnish.

CAUTION: If the tape-wrapped flathead screwdriver is inserted too deeply when detaching the windshield garnish clips A and clips B, it could damage the windshield. When detaching them, be careful not to scratch the windshield.

NOTE: There is no problem even if the windshield garnish and clips are damaged as they are replacement part and new parts should be used.

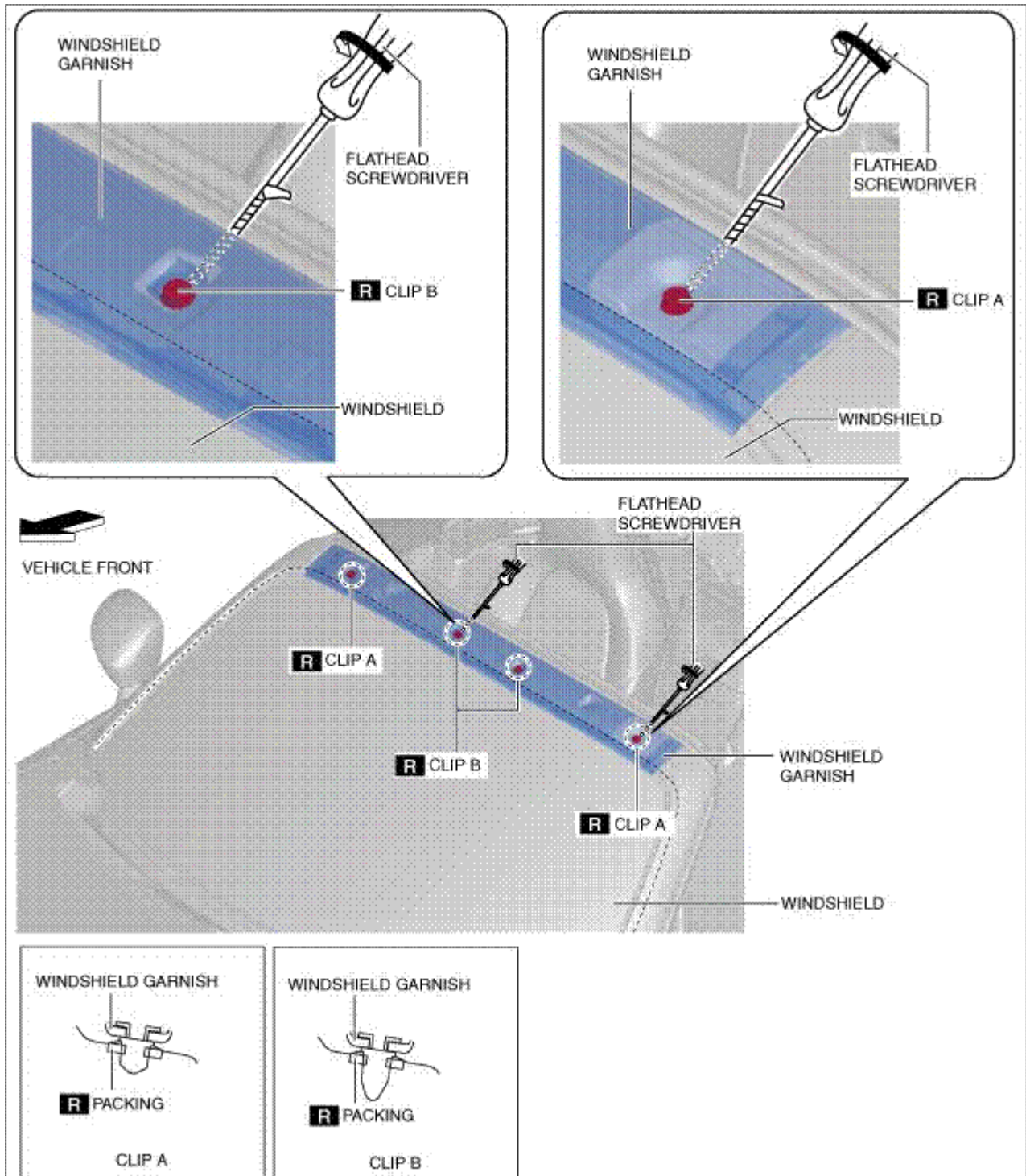

NOTE: If the clips remain in the body panel, remove them using the following procedure.

- 1) Apply a strip of masking tape to the front windshield to prevent damage to the windshield as shown.

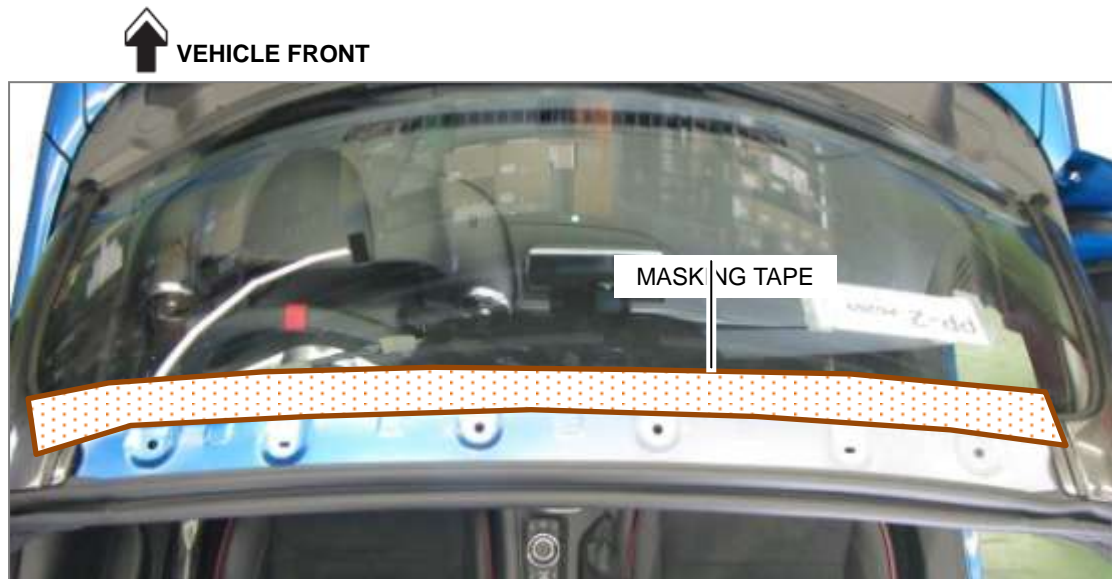

- 2) Rotate the clip and align the two position marks on it with the arrows in figure. (Perform the same procedure for all clips.)

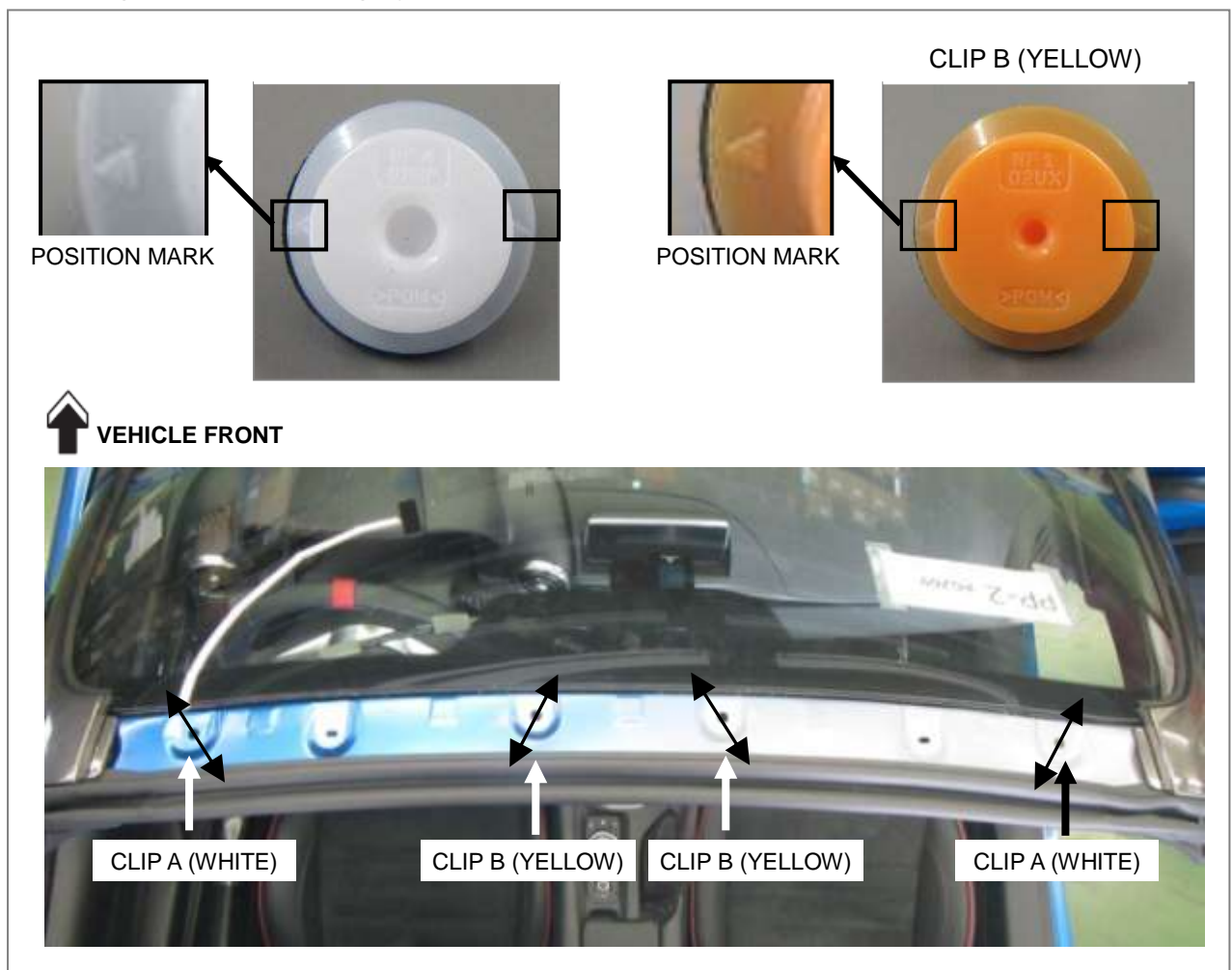

- 3) From the vehicle interior side, insert the tape-wrapped flathead screwdriver into the hole of the body panel below the clip as shown.



- 4) While pushing the bottom (lock tab) of the clip by the tape-wrapped flathead screwdriver, pull up the clip by holding the top with fingers.

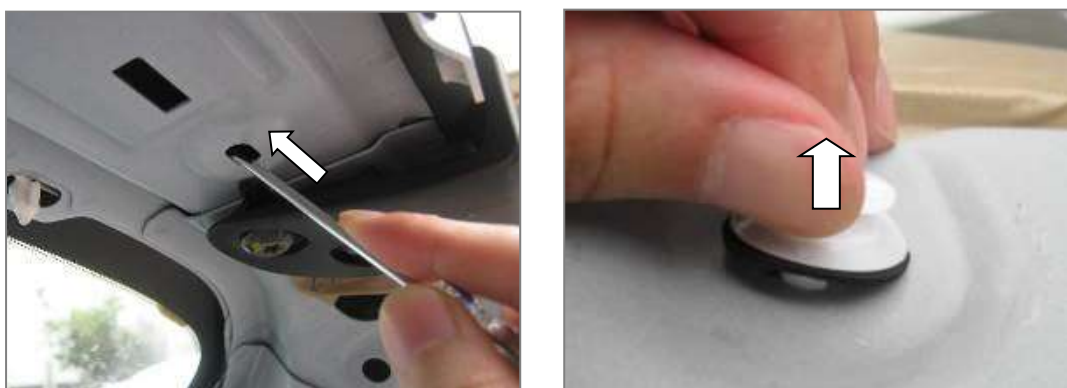

- 5) While keeping the clip being pulled up, rotate it to align the position marks with the arrows in figure.

NOTE: The figures show the right side white clip as a sample.

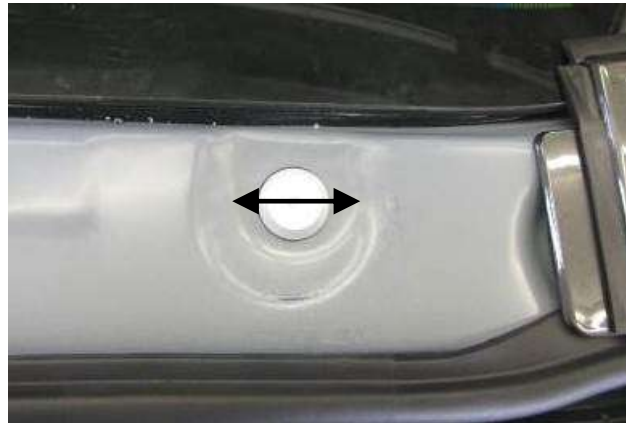

- 6) Insert a tape-wrapped fastener remover under the clip as shown.



- 7) Insert the tape-wrapped flathead screwdriver under the clip at the opposite side of the fastener remover as shown.



- 8) Slowly move both the fastener remover and flathead screwdriver to pry the clip out.
NOTE: DO NOT drop the clip in the engine compartment or other space and broken pieces inside the body panels.

↑ VEHICLE FRONT

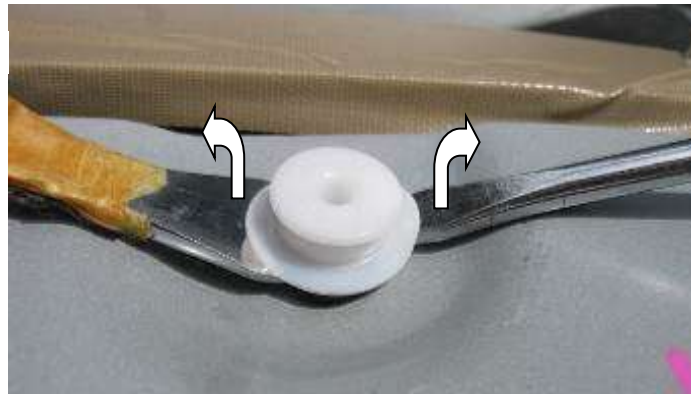

- 9) Remove the masking tape.

8. Install a new windshield garnish to the vehicle body panel according to the following procedure.

- 1) Put position marks of the clips by attaching pieces of tape to the windshield just below the four clip installation holes.

NOTE: Attach pieces of tape more than 30mm away from the clip installation holes.

↑ VEHICLE FRONT

POSITION MARKS



- 2) Prepare a new garnish and rotate the clip to align the position marks with the directions of the arrows in figure. (For all four clips)

↑ VEHICLE FRONT

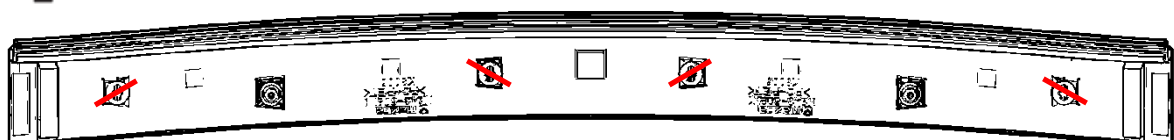

SERVICE HINT and CAUTION.

- Perform the following procedure while standing in the space behind the front seats. To do so, open the convertible top, fully slide the front seats forward and fold down the front seat backs.



- DO NOT install the garnish from the vehicle outside. Working in an unusual posture will cause improper clips installation of the windshield garnish.
- Be careful not to scratch the front seats and interior trims by kicking them with shoes while working in the back of the front seats.
- DO NOT tap clips with a hammer or fist while the installation.

- 3) Place the windshield garnish on the body panel by aligning the fixing bolts with the installation holes and the four clips with the clip installation holes.
- 4) Press the windshield garnish above the two clips B (YELLOW) at the same time with palms.
NOTE: Press it with a quick movement at a force of 150N.

CLIP B (YELLOW)



- 5) Press on the windshield garnish above the clip A (WHITE) with palms at a force of 150N to engage the clip. Perform the same procedure for the opposite side.

CLIP A (WHITE)



CLIP A (WHITE)



- 6) Verify that the clip is engaged completely by checking it through the hole as shown. (For all four clips)

NOTE: If any clip is not engaged completely, push it further to engage completely.

CLIP A (WHITE)

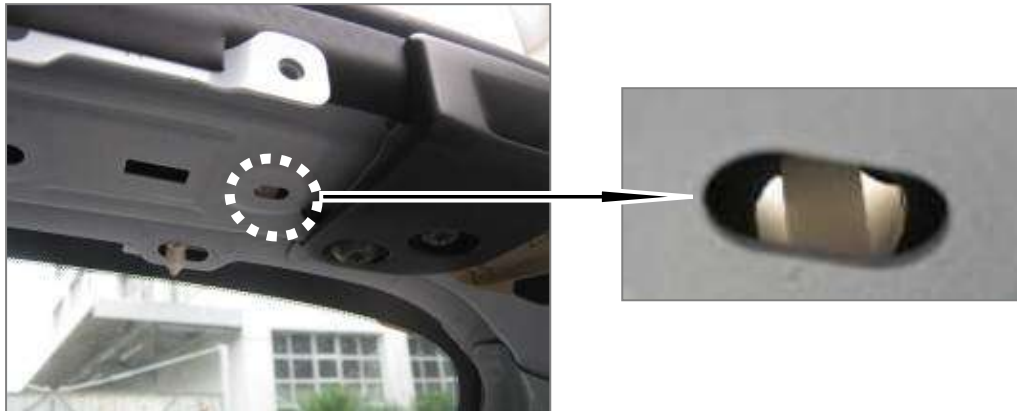

CLIP B (YELLOW)

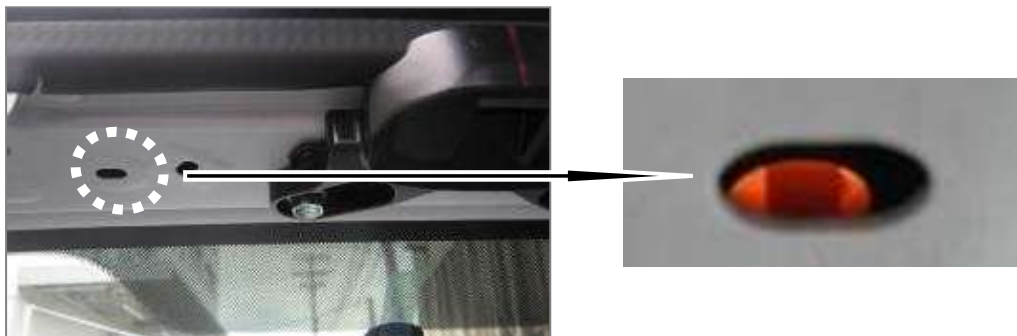

- 7) Tighten two nuts to 2.5 – 4.5 N·m.

9. Install other parts in the reverse order of removal.

END